

The First Demonstration: Proof That Air is a Substance

This lecture-demonstration is the first recorded in history. The demonstration was performed in 440 B.C. by the Greek physician Empedocles to confirm his belief that air is a "substance." With minor changes, this demonstration can be repeated.

Procedure

1. Fill a large container almost full of water.
2. Add a few drops of food coloring to make the level more visible.
3. Place your finger over the opening in the stem of a funnel and place the large open end of the funnel in the water.
4. Notice that the water does not enter the funnel.
5. Remove your finger from the opening. Notice, as Empedocles observed, that the water rushes into the large opening as the air rushes out of the small." Because air prevented the water from entering, air must, indeed, be a substance.

Teaching Tips

Notes

1. On the basis of this observation, Empedocles developed a "water clock." This clock was a conical container with a small hole in the top and a larger hole in the bottom. The cone sank in a certain amount of time, so it could be used as a crude time piece.
2. Ironically, this first demonstration can be easily documented and attributed to Empedocles more than 2300 years ago, although the origins of more recent demonstrations are much more difficult to trace.
3. By modern standards, this demonstration seems very simple and obvious. However, it was not the custom of early "scientists" to do experiments or demonstrations. This simple demonstration by Empedocles caused other Greek physicians to begin thinking about the role of air in breathing and other processes.

QUESTIONS FOR STUDENTS

1. Why do you think such a simple demonstration was important in the year 440 B.C.?
2. Would you give the same explanation as Empedocles?
3. Find out more about Empedocles, the Greek physician.
4. What is a demonstration?

Reprinted with permission from *Chemical Demonstrations...A Sourcebook for Teachers Volume 2*, Second Edition, Copyright 1988, American Chemical Society.

1.4. KEEP PAPER DRY UNDER WATER

- Materials:
1. A dry glass or transparent plastic cup.
 2. A large beaker or transparent plastic container (large enough to fit a person's hand).

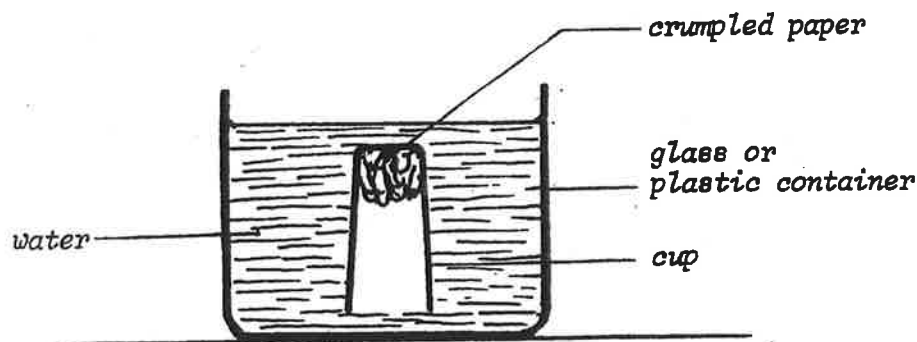

Procedure:

1. Fill the large container about 2/3 full with water.
2. Crumple a piece of dry paper and squeeze it to the bottom of the glass or plastic cup.
3. Invert the glass (making sure that the crumpled paper stays up in the cup) and immerse it completely under water, holding it as vertically as possible.
4. Take the cup back out of the water and let the water drip off (do not shake off!).
5. Take the crumpled paper out of the cup with a dry hand and let the students feel and check whether it is dry or not.

Questions:

1. Before inserting the crumpled paper, ask: "What is in the cup?" (anticipated answer: 'nothing').
2. Before immersing the glass under water, ask: "What else besides the paper is in the cup?"
3. While immersing the cup: "Why doesn't the water enter the cup?"
4. Why does the paper have to be crumpled?

Explanation:

Air is **space occupying**. The glass is therefore filled with air, no matter whether it is right side up or upside down. Besides the crumpled paper there was air in the cup. This is why the water could not enter the cup during the immersion process. The paper stayed therefore completely dry.

Applications of this characteristic of air can be found when people have to work under water. Air is then pumped in and around the area where the people are working, enclosed by a water-tight wall.

1.2. THE BOTTLE AND THE BAG

- Materials:
1. One or two plastic sandwich bags.
 2. One or two large wide-mouthed glass jars (pickle jars).
 3. Masking or transparent adhesive tape.

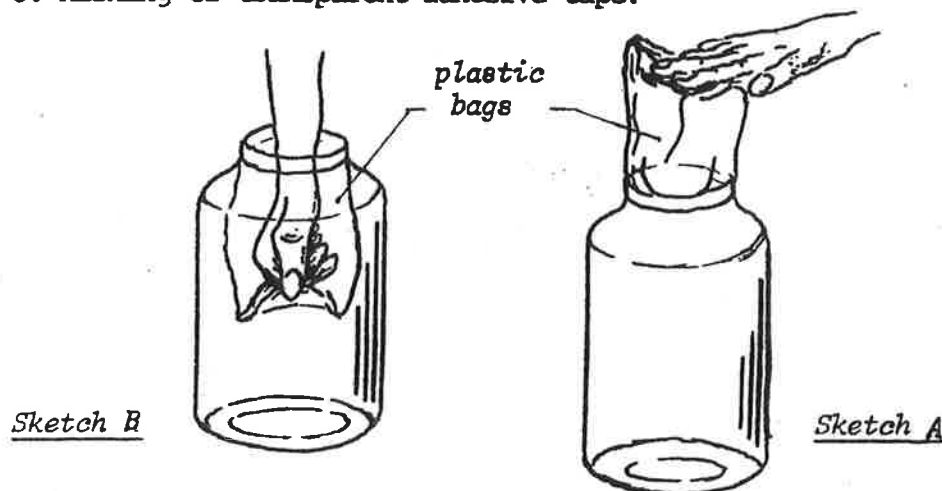
Procedure:

1. Invert the bag over the mouth of the jar, blow a little air in the bag such that it stays inflated over the jar (see Sketch A).
2. Tape the bag air-tight against the jar.
3. Now ask one of the students to push the bag into the jar (without tearing it): It won't work!
4. Place another plastic bag inside another wide-mouthed jar (or use the same bag and jar) and let the edge of the bag hang over the jar rim (see Sketch B).
5. Tape it air-tight against the jar and let a student try and take the bag out of the jar (without tearing it): It won't work!

Questions:

1. Before putting the plastic bag on the jar, ask: "What is inside the jar? Inside the plastic bag?"
2. What is holding the bag out of the jar? (when trying to push it in).
3. What is holding the bag inside the jar? (when trying to take it out).
4. How could we get the bag inside the jar without making a hole in it?

Explanation:

It is the air occupying the space in the jar which kept the bag from going inside after it had been taped air-tight against the jar. In trying to push the bag in, the pressure increased (because the volume decreased) and this held the bag out.

When trying to take the bag out of the jar, the air pressure inside the jar decreased, because the volume increased, and this kept the bag inside. The outside air pressure kept the bag inside the jar. We encounter the first situation often when we try to fold up a plastic air mattress or inflatable plastic toy.

1.15. THE STICKING CUP OF WATER

- Materials:
1. A petri dish (or other shallow dish with smooth rim).
 2. A smooth surface, ceiling, or underside of a table.

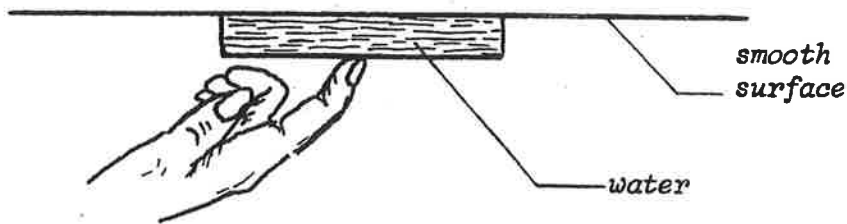

Procedure:

1. Fill the petri dish brim-full with water.
2. Bring the dish to the smooth surface: push it against the surface making sure that there are no air bubbles left in it.
3. At this point make sure that the dish will stick to the surface, then ask a student to hold it up or do as if you need to get something and have to leave the dish.
4. Give the student permission to let go of the dish or say: "Maybe I can let go of the dish" (if holding it yourself).

Questions:

1. Why do we need a smooth surface?
2. Why does the dish stick to the surface?
3. How much force is holding the dish up?
4. How heavy a dish can we stick to the surface?
5. How long will the dish keep sticking to the surface?

Explanation:

By filling the dish completely full with water, there is no air left and thus there is no air pressure working down on the dish. The only force working down on the dish is gravity and thus the weight of the dish plus the water. The force holding the dish against the surface is equal to the air pressure of 1 kg per cm^2 of dish surface area. A dish with a 3 cm radius will have a force of about 27 kg holding it up minus the weight of the water and the dish itself. Once the dish is sticking to the surface, it will stay up for quite a long time until some water evaporates and air seeps into the dish.

The water, in this case, acted as a seal preventing the air from coming into the dish. An application of this principle is when we wet suction cups with water to make them stick better to smooth surfaces.

1.23. INFLATE A BALLOON BY SUCKING

- Materials:
1. An empty glass jar & a fitting 2-hole stopper.
 2. Two lengths of glass tubing (one with a 90° bend).
 3. A small balloon & tape or rubber band.

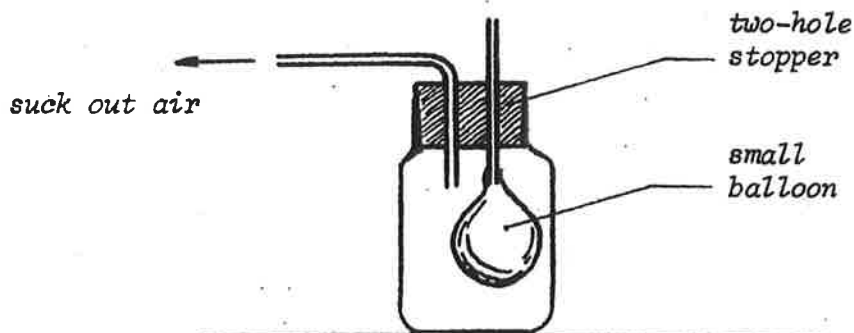

Procedure:

1. Insert the glass tubing into the stopper and tie or tape the small balloon to the end of the straight tube.
2. Place the stopper with the tubing and the balloon over the jar, insert tightly, and set up the equipment as shown in the sketch above.
3. Suck through the bent glass tube until the balloon is inflated and close off the end of the bent tube with your finger (prevent the air from getting back into the jar).
4. Ask the students all the questions.

Questions:

1. What was I doing to inflate the balloon?
2. How does the pressure inside the jar compare to the pressure outside the jar during inflation of the balloon?
3. Why doesn't the balloon deflate? (finger over end of bent tube).
4. How else can the balloon be inflated?
5. What would happen if I blew through the bent tube?
6. How does the pressure inside the jar compare to that of outside during inflation of the balloon by blowing through the straight tube?

Explanation:

By sucking through the bent tube, the pressure inside the jar is decreased and the atmospheric air pressure is inflating the balloon. By placing the finger over the end of the bent tube (after inflating the balloon), the air is prevented from reentering the jar. A lower pressure inside the jar (outside the balloon) is now maintained, which causes the balloon to stay inflated even with an open mouth. Another way to inflate the balloon is to blow through the straight tube, and by putting a finger over the bent tube it can be kept inflated. This way, during inflation the pressure inside the jar is higher than the atmospheric pressure.

1.29. SQUEEZE THE GLASS BOTTLE?

- Materials:
1. An empty glass bottle.
 2. Glass tubing (about 30 cm) in a fitting 1-hole stopper.
 3. Water and food coloring in a small beaker.

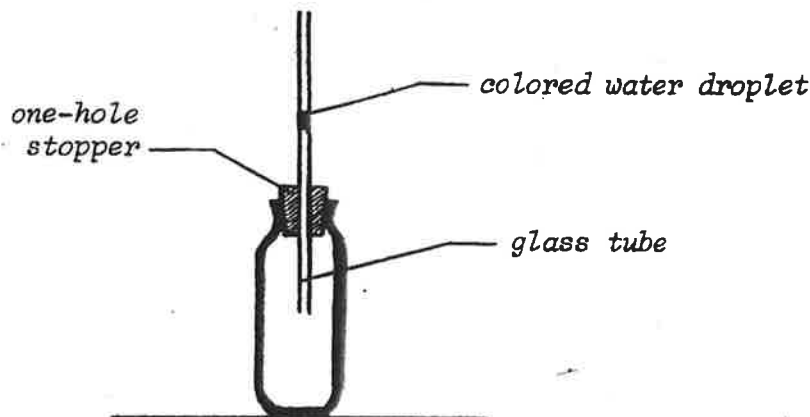
Procedure:

1. Color a few millilitres of water with food coloring in the beaker.
2. Dip the end of the glass tubing in the colored water and close the other end off with a finger. Take the tube out of the water, hold the tube horizontal and let the waterdrop ride in the tube until close to the stopper. (close off the end again with the finger).
3. Place the stopper in the bottle neck and insert tightly (waterdrop will move up some).
4. Mark off the position of the waterdrop with a grease pencil, masking tape, or rubber band.
5. Hold bottle in both hands: what happens to the waterdrop?
6. Let the bottle stand on the table: what happens to the waterdrop?

Questions:

1. What is in the bottle?
2. Why does the waterdrop not slide down into the bottle?
3. Why does the waterdrop move up when inserting the stopper?
4. What made the waterdrop move up when the bottle was held?
5. How can we get the waterdrop to move down the tube?

Explanation:

The 'empty' bottle is of course filled with air. In closing off the bottle with the stopper and tube, the waterdrop was pushed upwards by the air. It is because of the presence of air inside the bottle that the waterdrop in the tube cannot slide down by itself. It is actually held up in the tube by the air.

By holding the bottle in our hands, our body heat is warming up the bottle, which in turn warms the air. This air expands and pushes the waterdrop up the tube. By cooling the bottle with cool water and blowing, the waterdrop can be made to move down the tube.

1.31. THE DANCING PENNY

- Materials:
1. One empty bottle with a narrow neck.
 2. One large beaker or container for warm water.
 3. A penny or dime, or other small coin.

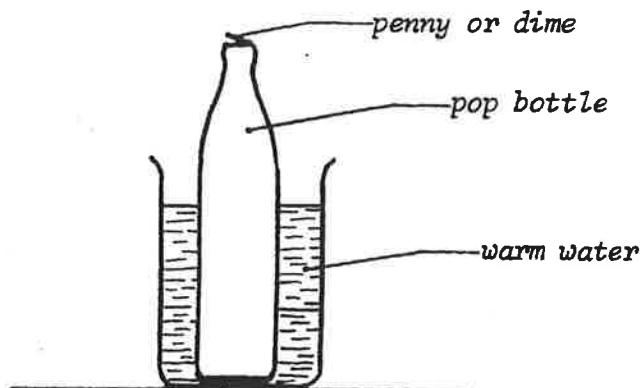
Procedure:

1. Moisten the opening of the bottle and place the penny or dime flat on the bottle mouth.
2. Fill the large beaker with hot water (not steaming, so that it would look like cold water; if possible fill this container before doing the demonstration).
3. Immerse the bottle, which is covered with the penny, in the water and observe the dancing coin.

Questions:

1. What was in the bottle before covering it with the coin?
2. What kind of water was in the beaker?
3. What was the moisture on the bottle opening necessary for?
4. Why did the penny or dime go up and down (vibrate)?
5. Would it also vibrate without moisture on the opening of the bottle?

Explanation:

The bottle was filled with air before covering it with the coin. The moisture on the opening of the bottle functions as a seal between the inside and outside of the bottle. When the bottle is placed in the hot water, the air inside the bottle is heated and this causes the air inside the bottle to expand. The only way it can escape from the bottle is through the opening, and thus it has to lift the coin. The coin falls back, more air expands and lifts up the coin again. When this sequence of events happens quickly, a vibration of the dime is caused.

Without the moisture on the opening of the bottle, the coin does not seal off the air, so that the escaping air from inside the bottle could just seep under the coin out into the open without lifting the coin. The coin would thus not vibrate.

1.39. THE PLASTIC BAG AIR LIFT

- Materials:
1. Twelve to twenty medium size garbage bags (plastic).
 2. Two identical flat top tables.

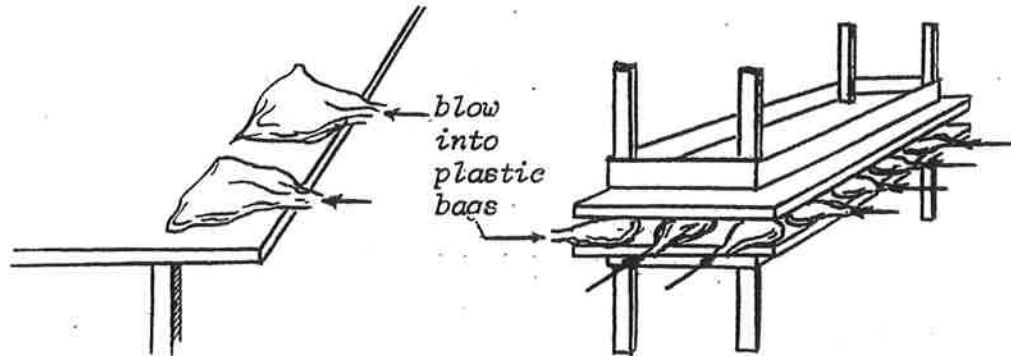
Procedure:

1. Ask as many students as can possibly stand around one of the tables to stand around the table and give them each a plastic bag.
2. Let them spread the bags out on the table and hold the bag's mouth in their hands to get set to blow air in them (let the students stay in a squatting position around the table).
3. Make sure that all students are ready to blow air into the bags with their hands and fingers away from the table top!
4. Ask two or four other students to lift the other identical table, turn it upside down and put it slowly on the first table (this has to be done carefully as it has to move over the heads of the students!).
5. Ask one or two students to climb up and sit on top of the set of tables.
6. Let the squatting students now blow air in the plastic bags all together on the count of three.

Questions:

1. Did you expect a heavy weight like that to be lifted by air?
2. What made the top table rise?
3. How did the pressure of the air inside the plastic bags compare to the outside atmospheric air pressure?
4. Where do we find applications of this principle?

Explanation:

By blowing in the plastic bags, air is being compressed. This compressed air is exerting pressure underneath the inverted table causing the table to rise. This principle is being applied when pumping tires of a bicycle or automobile, or compressing air in air lifts (at gas stations or garages). Tire pressures are twice or four times as high as the atmospheric pressure, and in air lifts these pressures go as high as 20 to 50 atmospheres.